

---

RBSP EFW  
SOC  
Software Development Plan  
RBSP\_EFW\_SOC\_001\_SDP

Draft

John W. Bonnell  
University of California, Berkeley  
Revision - A

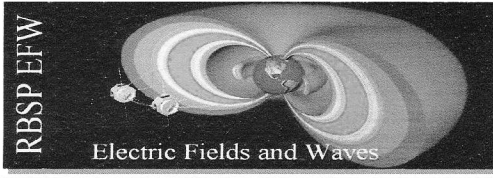

## Approvals

PM Approval:

 10-10-2008  
Keith Goetz, RBSP EFW PM

Co-I/SOC Approval:

 20 OCT 2008  
John Bonnell, RBSP EFW Co-Investigator

IDPU Approval:

 10/1/08  
Michael Ludlam, RBSP EFW IDPU Lead

GSE Approval:

 10/1/08  
William Rachelson, RBSP EFW SOC/GSE Lead

SysEng Approval:

 2008-9-30  
Dave Curtis, RBSP EFW SysEng

QA Approval:

 9-30-08  
Ron Jackson, RBSP EFW Quality Assurance

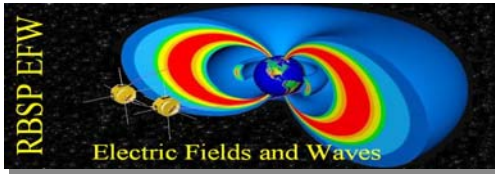

## Changes

Description	
A	Initial Version

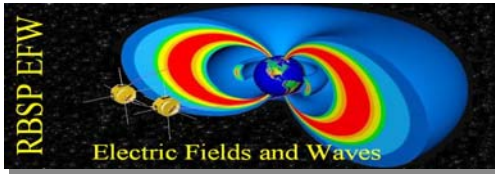

## Distribution List

Name	Email (thm_backplane)
John Bonnell, EFW Co-I	<a href="mailto:jbonnell@ssl.berkeley.edu">jbonnell@ssl.berkeley.edu</a>
Michael Ludlam, EFW IDPU	<a href="mailto:mludlam@ssl.berkeley.edu">mludlam@ssl.berkeley.edu</a>
William Rachelson, EFW SOC/GSE	wrachelson@ssl.berkeley.edu
Keith Goetz, EFW Project Manager	goetz@waves.space.umn.edu
Ron Jackson, EFW Quality Assurance Manager	rjackson@ssl.berkeley.edu
Dave Curtis, EFW System Engineer	dwc@ssl.berkeley.edu

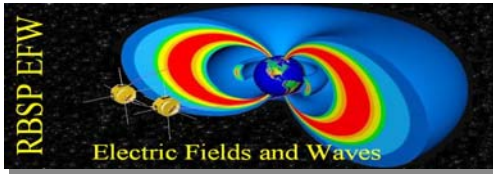

## 1. Introduction

The following document is the development plan for SOC and GSE software for the RBSP EFW Instrument. Because of the radically different levels of oversight required for SOC and GSE software as compared with instrument Flight Software (FSW), the development of said software is described separately from that of the EFW FSW.

### 1.1 Project Definition

The RBSP EFW instrument is composed of four Spin-Plane Electric Field Booms (SPBs), two Axial Electric Field Booms (AXBs) and an Instrument Data Processor Unit (IDPU). The IDPU is responsible for power conversion, boom deployment, sensor electronics, command and telemetry processing. The GSE and SOC software is principally engaged in instrument commanding and data playback, processing, and storage, during all phases of instrument development, integration, and on-orbit operation. While many elements of the software has a great deal of heritage, it is expected that the RBSP EFW SOC and GSE package will be a unique product and will be tested as such.

### 1.2 Reference Documents

These documents are available on the RBSP EFW ftp site.

<ftp://apollo.ssl.berkeley.edu/pub/RBSP/>

Ref	File	Description
[1]	TBD	TBD

## 2. Project Organization

The project is organized as shown in the figure 2-1. UMN is the lead institution, with UCB providing the technical expertise and effort on the SOC and GSE software development. The EFW System Engineer maintains all GSE and SOC

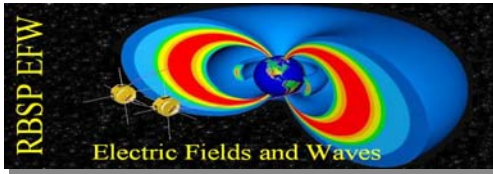

requirements. The Science Team SOC/GSE Lead provides the interface between the top-level measurement requirements and the development of the GSE and SOC software needed to implement those requirements. The SOC Lead heads development of GSE and SOC software, the CTG (GSE) Lead develops the GSE aspects of the SOC, while the SOC and SDC Leads head development of the SDC and end-user data analysis tools. Not shown explicitly in this org chart are the IDPU and Science team members that will serve as testers and end users for the GSE and SOC software.

Note that the SDC Lead is expected to be picked up in Q2 to Q3-2009 by UCB personnel transitioning off of the THEMIS MOC/SOC effort or other software projects, consistent with the project-level Ground Software development schedule (Build 1, Aug 2009), as well as consistent with (and very early with respect to) the EFW I&T schedule (F1 and F2 deliveries to SC I&T in Aug-Sep 2010).

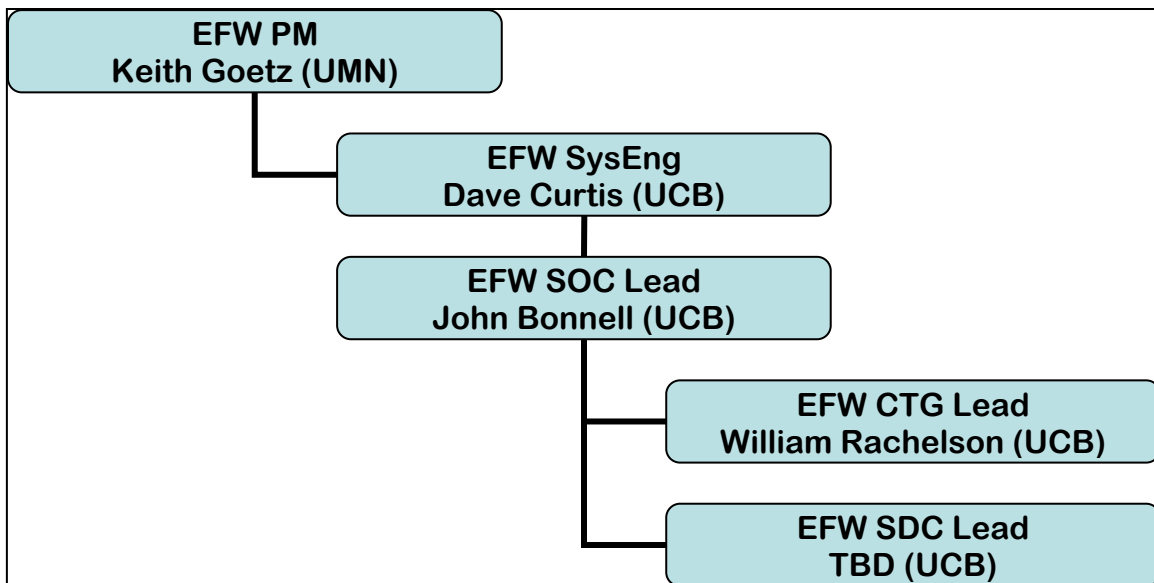

Figure 2-1. SOC/GSE Development Team Organization

## 2.1 Scope of Development

Software will be developed for the EFW SOC Command, Telemetry, and GSE module, as well as the Science Data center modules.

## 2.2 Metrics Used During Software Development

The following metrics will be used during software development:

1. Action item tracking (routine and peer review).
2. EVM statistics (e. g. rate of completion vs. schedule).
3. bug reporting (e.g. via bugzilla).

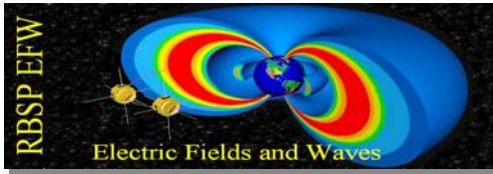

- 
4. software change requests (SCRs).

### **2.3 Metrics and Configuration Control**

Requirements on the SOC and GSE will be tracked internally via Excel, with reference to requirement and version in modules as needed. SVN will be used for day-to-day version control of source code and data. Software PFRs and SCRs will be tracked via Excel and documentation stored on the RBSP-EFW FTP site. All code will be backed up daily through the usual IT support at UCB (to disk on-site: daily; to tape and to off-site storage: monthly).

## **3. Software Development Overview**

The RBSP SOC software is comprised of two primary modules: The Command, Telemetry and Ground Support (CTG) module, and the Science Data center Module (SDC).

Figure 1 to Figure 6 provide a functional representation of these two modules and the CSCIs that comprise them. The information fulfilling Item 8 of the SW-001 DID (software class, description, user, schedule milestones and accomplishments, documentation, re-use, development and use platforms, development languages and tools, etc.) is collected for each CSCI in Table 1.

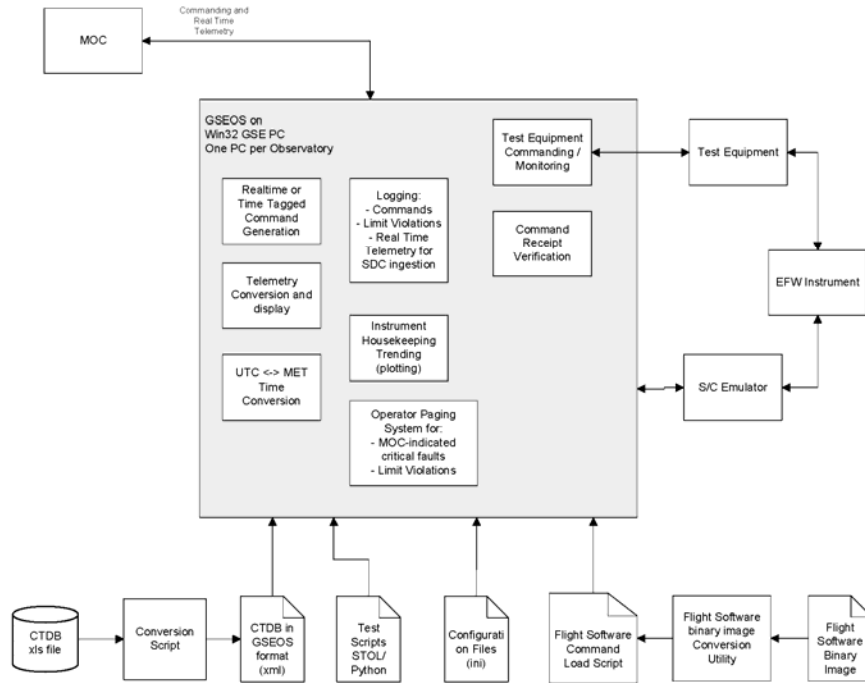
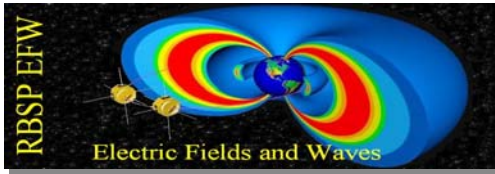

EFW CTG

Figure 1: Command, Telemetry, and Ground Support data flow.



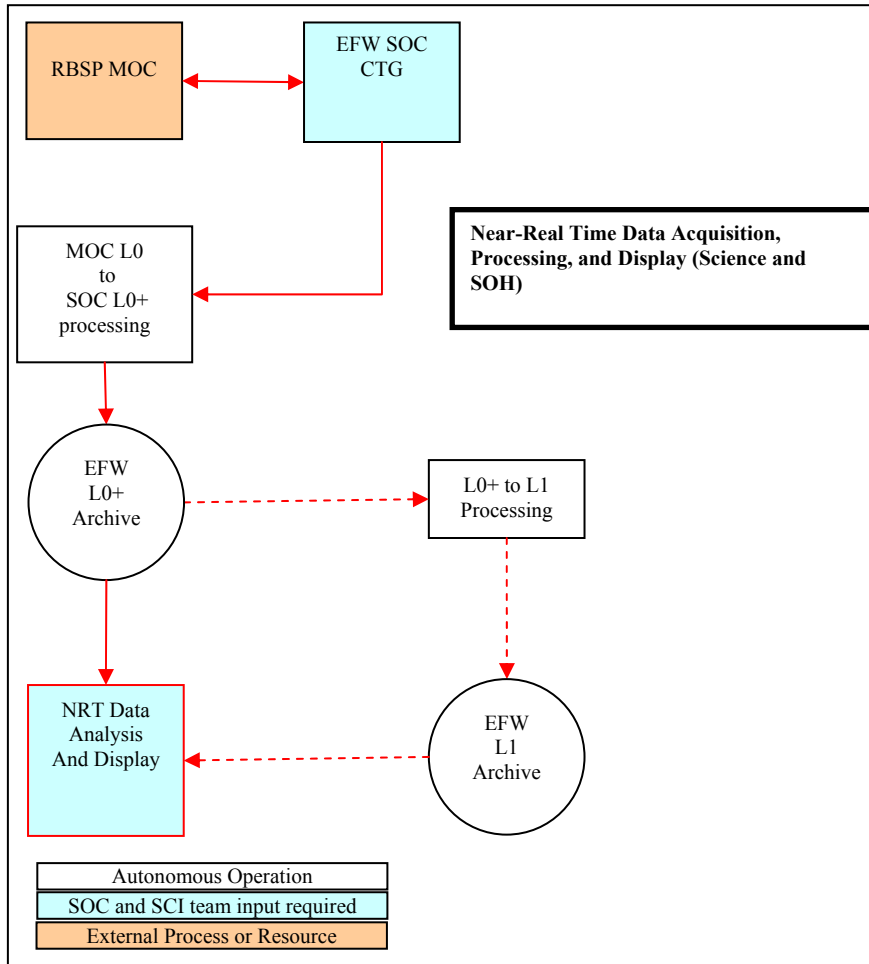
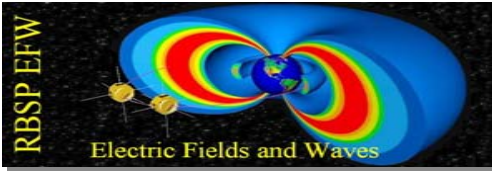

Figure 2: Near-Real Time Data Processing Flow.

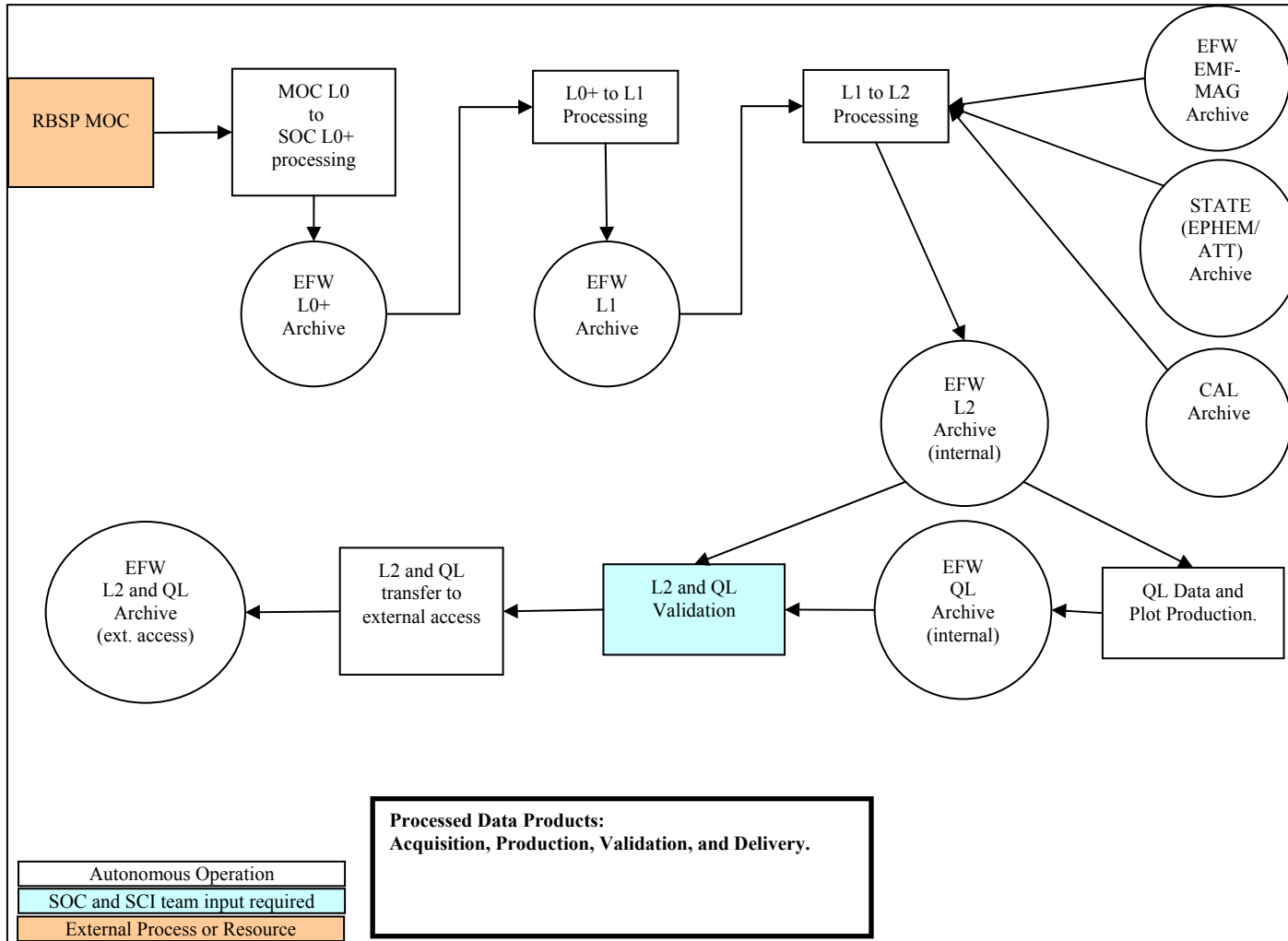
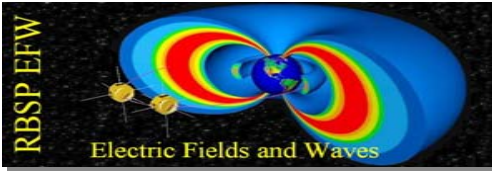
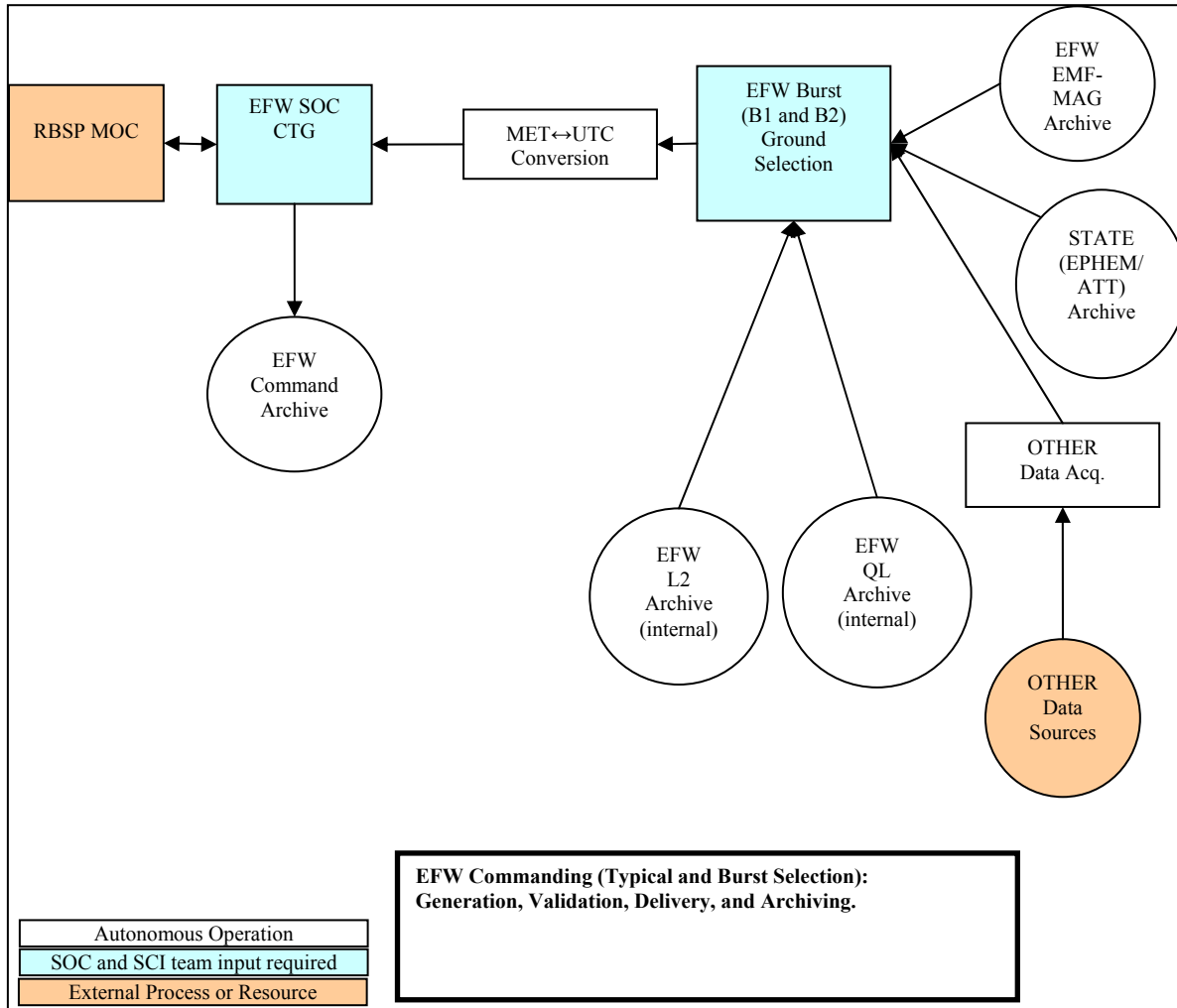
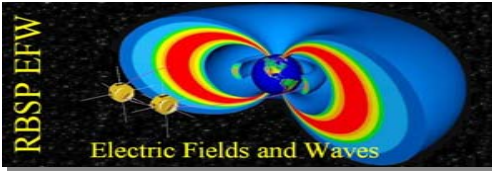

Figure 3: Processed Data Products and Data Validation flow.



**Figure 4: Instrument Commanding and Ground Burst Selection flows**

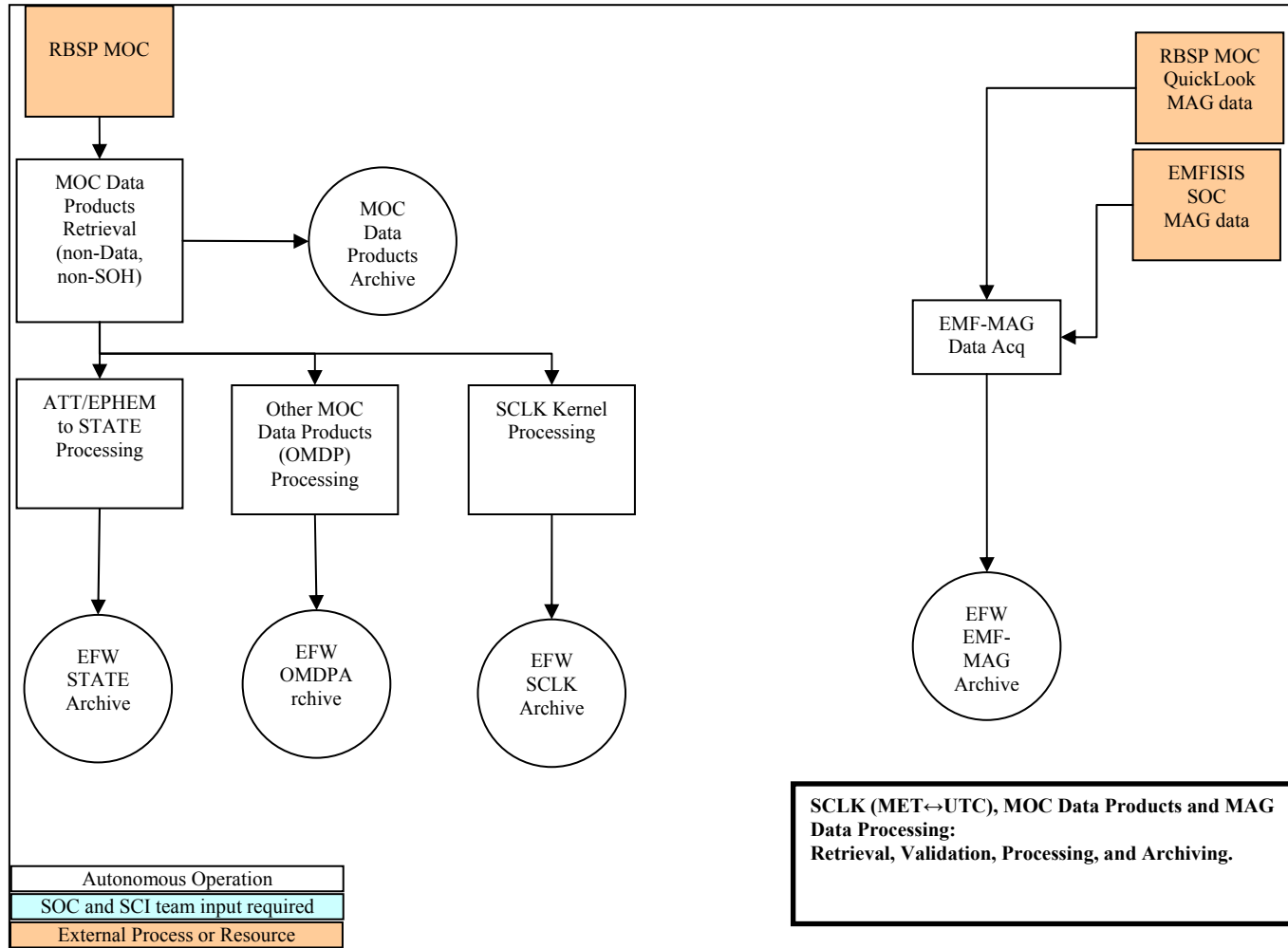
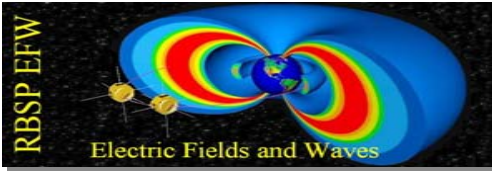

Figure 5: MOC Data Products and MAG Data flows.

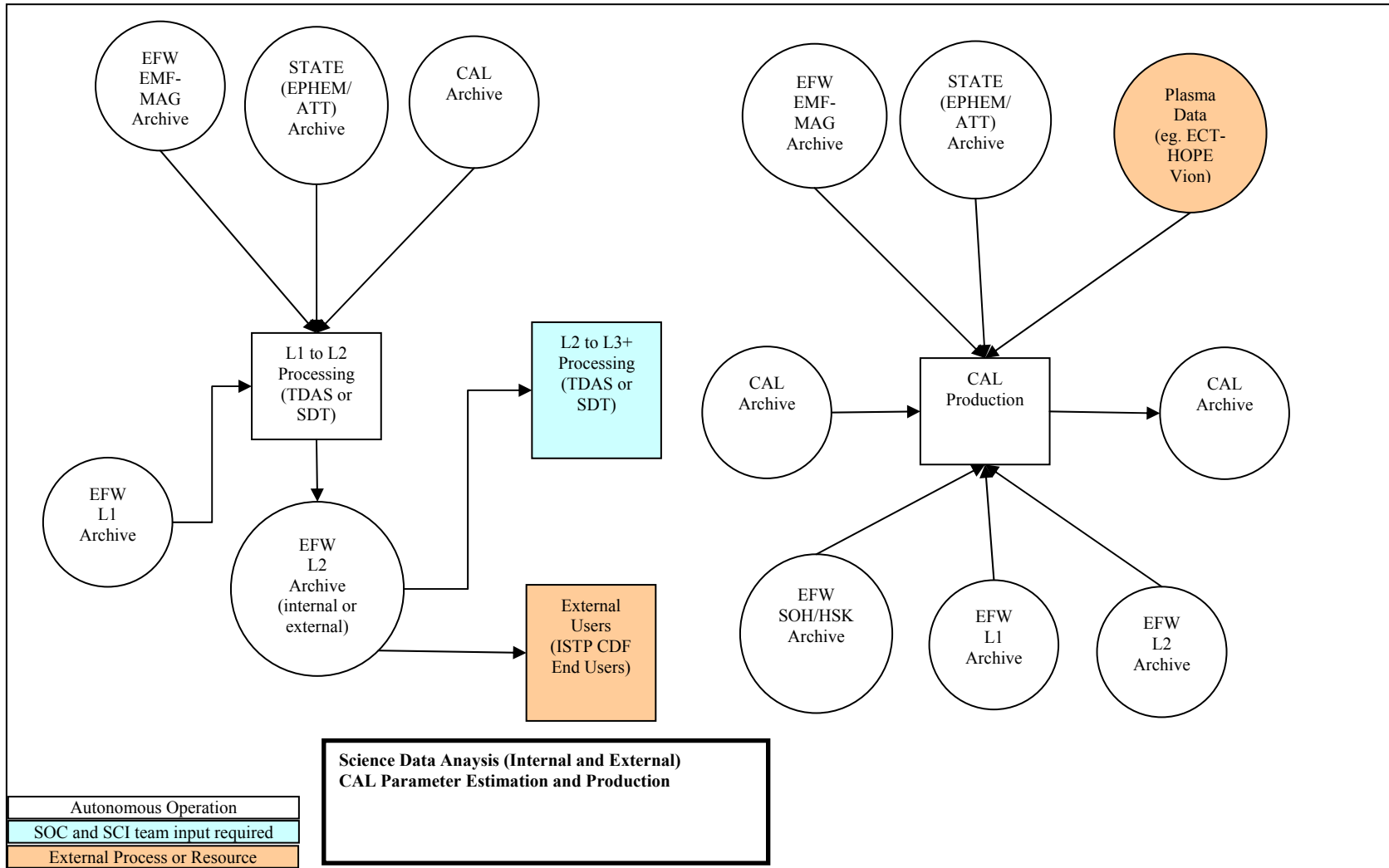
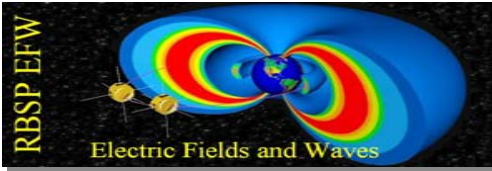
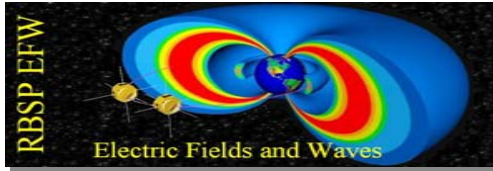
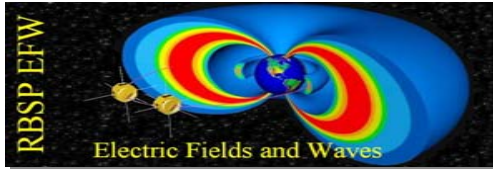

Figure 6: Science Data Analysis flow.

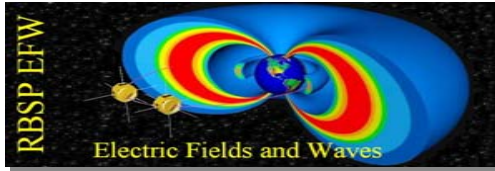

**Table 1: EFW SOC Software Development Plan -- CSCI Description and Development.**

CSCI	Description	Class [as per NASA-STD-8739.8 Change 1]	Users	Schedule Milestones And Accomplishments	Non-Delivered Documentation	Development Platform	Development Language	Development Tools	Run Platform	Reuse
CTG-CTG	Command, Telemetry and Ground Support (CTG): instrument command and telemetry handling in both I&T and on-orbit configurations.	C	EFW I&T and SOC team	EFW ETU I&T: support for instrument commanding and data playback.	TBD	Windows	GSE OS, C, Python	SVN	Windows PC	None.
SDC-NRT	Near-Real Time: near-real time data and instrument SOH acquisition, processing, and display.	D	EFW I&T, SOC, and SCI teams.	EFW ETU I&T: support for instrument data playback and archiving. EFW FLT I&T: support for instrument data playback and archiving. SC I&T: Support of instrument data	TBD	Windows, Unix.	GSE OS, Python,C, IDL.	SVN	Windows PC.	L0+ to L1 processing (utilities and scripting) inherited from THEMIS-EFI data processing .  Data



				<p>playback and archiving. SC Mission Sims, EFW Commissioning, Main Mission: Support of instrument data playback and archiving.</p>						<p>display and analysis (IDL procs and cribs) inherited from THEMIS-EFI data processing .</p>
SDC-PDP	<p>Processed Data Products: acquisition of playback data and production of science data products (L0+, L1, L2, and QL)</p>	D?	EFW SOC and SCI teams.	<p>Main Mission: Support of instrument data playback, archiving, and processing to science data products.</p>	<p>Instrument data products and calibration documents.</p>	<p>Windows, Unix.</p>	<p>GSE OS, Python, IDL.</p>	<p>SVN</p>	<p>Windows or linux PC.</p>	<p>L0+ to L1, L1 to L2 processing (CDF formats, utilities, scripting) inherited from THEMIS-EFI data processing .</p>
SDC-DVAL	<p>Data Validation: validation of L2 and QL data products for distribution to external users.</p>	D?	EFW SOC and SCI teams.	<p>Main Mission: Support of export of validated data to external users.</p>	<p>TBD</p>	<p>Windows, Unix.</p>	<p>GSE OS, Python, IDL.</p>	<p>SVN</p>	<p>Windows or linux PC.</p>	<p>None.</p>
SDC-BSEL	<p>Burst Selection: Ground selection of B1 and B2 burst</p>	D?	EFW SOC and SCI	<p>Main Mission: Support of instrument commanding.</p>	<p>TBD</p>	<p>Windows, Unix.</p>	<p>GSE OS, Python, IDL.</p>	<p>SVN</p>	<p>Windows or linux PC.</p>	<p>None.</p>



	waveform data products for playback.		teams.							
SDC-MDP	MOC Data Products: Retrieval, processing, and archiving of MOC data products.	D?	EFW SOC and SCI teams.	Mission Ground SW – Build 1: Support of acquisition of MOC data products. SC Mission Sims, EFW Commissioning, Main Mission: Support of instrument data playback, processing and archiving; instrument commanding.	TBD	Windows, Unix.	GSE OS, Python, IDL.	SVN	Windows or linux PC.	None.
SDC-MAG	MAG Data Products: Retrieval, processing, and archiving of QL-MAG and EMFISIS-MAG data products.	D?	EFW SCI team.	Mission Ground SW: Support of acquisition of MOC data products. SC Mission Sims, EFW Commissioning, Main Mission: Support of instrument data playback, processing and	TBD	Windows, Unix.	GSE OS, Python, IDL.	SVN	Windows or linux PC.	None.



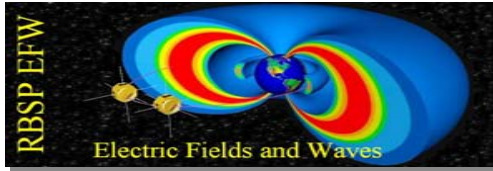

				archiving.						
SDC-ODP	Other Data Products: Retrieval, processing, and archiving of OTHER GEOPHYSICAL data products.	D?	EFW SCI team.	Main Mission: Support of instrument commanding and ops planning.	TBD	Windows, Unix.	GSE OS, Python, IDL.	SVN	Windows or linux PC.	None.
SDC-SDA	Science Data Analysis: Production of L2 and higher data products; actual science work.	D?	EFW SCI team.	Main Mission: Support of processed data production and archiving; doing some SCIENCE, for goodness sake!	TBD	Windows, Unix.	IDL, C.	SVN	Windows or linux PC.	EFI-related portions of THEMIS Data Analysis Software (TDAS) package (IDL procs and cribs). Existing Science data Tool modules (C).
CAL	Calibration: Production of EFW calibration data.	D	EFW SCi team.	Main Mission: Estimation of calibration parameters needed for the production of science data products.	Calibration parameter estimation description; CAL parameter files.	Windows, unix.	IDL.	SVN	Windows or linux PC (IDL).	EFI-related portions of THEMIS Data Analysis Software (TDAS) package (IDL procs and cribs).

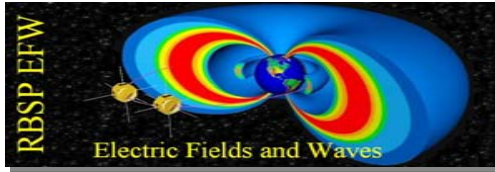

---

										Existing Science data Tool modules (C).
--	--	--	--	--	--	--	--	--	--	---