

---

# **RBSP EFW**

## **Verification, Validation, Test, and Calibration Plan**

RBSP\_EFW\_TE\_001  
10/6/2010  
Rev L

---

Michael Ludlam, EFW Systems Engineer

---

Keith Goetz, EFW Project Manager

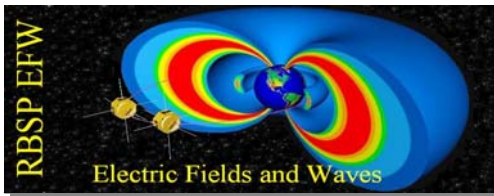

## Document Revision Record

Rev.	Date	Description of Change	Approved By
D	Aug 11 2008	Draft Released	-
E	Dec 4 2008	Baseline release	
F	June 26, 2009	Updates in response to APL comments	
G	September 13, 2009	Update to calibration section as per JWB comments	
H	December 10 <sup>th</sup> 2009	Update to FM I&T Flow, ETM	
J	December 11 <sup>th</sup> 2009	Minor Updates	
K	October 1 <sup>st</sup> 2010	Updates from Comment from APL	
L	October 11 <sup>th</sup> 2010	Minor Updates from comments from KAG.	

## Distribution List

Name	Email
Keith Goetz, EFW Project Manager, UMN	<a href="mailto:goetz@umn.edu">goetz@umn.edu</a>
John Wygant, PI, UMN	<a href="mailto:jwygant@fields.space.umn.edu">jwygant@fields.space.umn.edu</a>
John Bonnell, EFW CoI, UCB	<a href="mailto:jbennell@ssl.berkeley.edu">jbennell@ssl.berkeley.edu</a>
Bob Ergun, EFW CoI, LASP	<a href="mailto:ree@lasp.colorado.edu">ree@lasp.colorado.edu</a>
Paul Turin, EFW Mechanical Systems, UCB	<a href="mailto:pturin@ssl.berkeley.edu">pturin@ssl.berkeley.edu</a>
Michael Ludlam, EFW Systems / Electrical, UCB	<a href="mailto:mludlam@ssl.berkeley.edu">mludlam@ssl.berkeley.edu</a>
Greg Dalton, EFW SPB Lead, UCB	<a href="mailto:gdalton@ssl.berkeley.edu">gdalton@ssl.berkeley.edu</a>
Jeremy McCauley, EFW AXB Lead, UCB	<a href="mailto:JAMMRS@aol.com">JAMMRS@aol.com</a>
Mary Bolton, DFB Project Manager, LASP	<a href="mailto:mary.bolton@lasp.colorado.edu">mary.bolton@lasp.colorado.edu</a>
Susan Batiste, DFB Systems Engineer, LASP	<a href="mailto:susan.batiste@lasp.colorado.edu">susan.batiste@lasp.colorado.edu</a>
Jorg Fischer, QA, UCB	<a href="mailto:jorg@ssl.berkeley.edu">jorg@ssl.berkeley.edu</a>

## TBD List

Identifier	Description

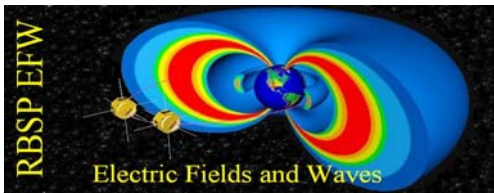

## Table of Contents

<b>Document Revision Record.....</b>	<b>2</b>
<b>Distribution List .....</b>	<b>2</b>
<b>TBD List .....</b>	<b>2</b>
<b>1. Introduction.....</b>	<b>4</b>
1.1 Overview .....	4
1.2 Scope .....	4
1.3 Applicable and Related Documents .....	4
1.4 Definitions.....	5
<b>2. Validation Plan.....</b>	<b>5</b>
<b>3. Functional Verification Plan.....</b>	<b>5</b>
3.1 Comprehensive Performance Test (CPT).....	6
3.2 Limited Performance Test (LPT) .....	7
3.3 Aliveness Test (AT).....	7
3.4 EMFISIS Interface Tests .....	7
3.5 Spacecraft Interface ETU Test .....	8
3.6 Boom Deployments.....	8
3.7 Observatory-Level Boom Deployments.....	9
3.8 Verification Other than Test.....	10
<b>4. Science Calibrations.....</b>	<b>10</b>
4.1 Science Calibration (SciCal) .....	11
4.2 Fields Timing and Phasing (FTP).....	11
4.3 Omnibus DFB Spectral Data Test .....	11
4.4 Slew Rate and DC and AC CMRR Test.....	12
4.5 Guard and Usher Test.....	12
<b>5. Environmental Test Program .....</b>	<b>12</b>
5.1 ETU Testing .....	13
5.2 Flight Unit Environmental Testing.....	14
<b>6. Integration and Test .....</b>	<b>18</b>
6.1 Integration and Test Flow .....	18
6.2 Integration and Test Facilities .....	19
6.3 Limited Life Items.....	20
6.4 Contamination and Control .....	20
6.5 Transportation and Preservation of the Instrument.....	20
<b>7. Environmental Test Matrix (Rev D) .....</b>	<b>21</b>
<b>8. Test Documentation .....</b>	<b>21</b>

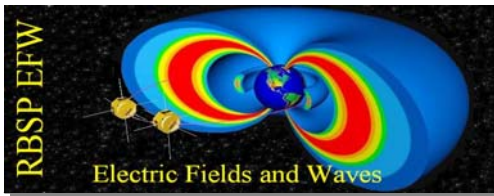

## 1. Introduction

### 1.1 Overview

The purpose of the Electric Field and Waves (EFW) Instrument is to measure the 3-D low frequency electric fields associated with a variety of mechanisms causing energetic particle energization, scattering, and transport in the inner magnetosphere. The instrument also provides measurements of cold (<30eV) plasma density measurements from the spacecraft potential and measurements of the scale sizes of small-scale plasma structures through interferometric timing.

Understanding the role of these mechanisms in the acceleration of energetic particles from their source populations requires electric field measurements over time scales of hours to  $10^2$  seconds and over an amplitude range from 0.3 mV/m to 300 mV/m using 80 m and 100 m (tip to tip) pairs of booms deployed orthogonally in the spin plane of the spacecraft. The accuracy of the spin plane electric field measurement is the larger of 0.3 mV/m or 10% of the field strength.

The RBSP EFW Instrument consists of the Instrument Data Processor (IDPU), the four Spin Plane Booms (SPB), and the Axial Boom assembly (AXB).

### 1.2 Scope

This document provides a plan for validating and verifying the performance and environmental test requirements levied on the RBSP EFW Instrument as defined within the applicable documents. The purpose of this plan is to describe the process through which UCB will (1) ensure the system is capable of surviving the predicted launch and space environment and (2) verify all elements of the system are compatible with each other and are capable of obtaining the required mission performance as described in the Instrument Requirements Document, RBSP\_SYS\_001. The design and test requirements described in this document are consistent with the environments described in the RBSP Environmental Specification, 7417-9019.

### 1.3 Applicable and Related Documents

RBSP\_EFW\_SYS\_001, RBSP EFW Instrument Requirements Document  
RBSP\_EFW\_Waivers, List of RBSP Deviations and Waivers submitted to CCB  
RBSP\_EFW\_PA\_005A Contamination Control Plan  
RBSP\_EFW\_PA\_007A Bakeout Plan  
7417-9013, RBSP Mission Requirements Document (MRD)  
7417-9148, RBSP Science Team Allocated Requirements Document (STARD)  
7417-9019, RBSP Environmental Design and Test Requirements (EDTRD)  
7417-9018, RBSP Electromagnetic Environment Control Plan (EMECP)  
7417-9024, RBSP System Verification and Validation Plan

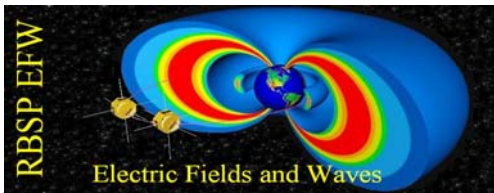

7417-9083, RBSP Interface Control Document (ICD) for the EFW investigation

7417-9096, RBSP EFW Compliance Matrix

7417-9011, RBSP Contamination Control Plan (CCP)

7417-9089, EFW to EMFISIS Electrical ICD

RBSP EFW documents can be found at:

[ftp://apollo.ssl.berkeley.edu/pub/RBSP/1.2.%20Systems/RBSP\\_EFW\\_SYS\\_000\\_Document\\_List.xls](ftp://apollo.ssl.berkeley.edu/pub/RBSP/1.2.%20Systems/RBSP_EFW_SYS_000_Document_List.xls)

RBSP APL Documents (7417-XXXX) can be found on the APL Forum at:

<https://sd-forum.jhuapl.edu/RBSP-IT/RBSP-IT/dispatch.cgi/admin>

## 1.4 Definitions

**Instrument:** The EFW Instrument package

**Component:** A major distinguishable part of an Instrument (i.e. IDPU, Spin Plane Boom (SPB), or Axial Boom (AXB))

**Assembly:** A major functionally complete part of an Instrument component (i.e. Boom Electronics Board (BEB) for the EFI, SPB Motor, etc.)

**Sub-Assembly:** The level below an assembly. Usually refers to a circuit board or a specific part of a mechanical assembly (i.e. Actuator for SPB Doors)

## Hardware Units

**Engineering Test Unit:** Hardware that is built specifically for testing. Usually is a faithful representation of a flight unit (without flight quality EEE parts for example).

**Flight Unit:** Hardware that is planned for flight.

**Qual Unit:** An engineering unit built specifically for qualification testing.

## 2. Validation Plan

The RBSP EFW Validation Plan will comply with the RBSP System Verification and Validation Plan, (7417-9024). The EFW System Engineer will validate that the EFW requirements, as documented in RBSP\_EFW\_SYS\_001 and subassembly specifications meet the higher level requirements for instruments in general and EFW in particular as documented in the STARD (7417-9148). The EFW Science Team shall validate that the documented EFW Instrument Requirements will allow the EFW to meet the top level RBSP Science goals. The Instrument Requirements Document shall show traceability of EFW requirements to STARD Requirements. The System Engineer will review all test procedures to ensure that they verify the relevant requirements.

## 3. Functional Verification Plan

Each requirement shall be verified at the highest level of assembly possible. In addition, functional testing will take place earlier, at lower levels of assembly, to reduce risk. Any requirements which can only be verified at a lower level of assembly shall be identified to ensure that that testing is carried out adequately. Each subassembly shall be functionally

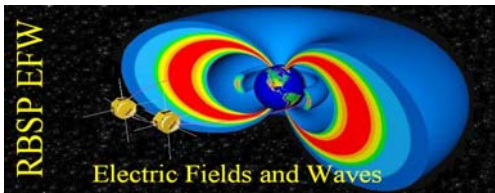

tested to verify that it meets its functional requirements prior to assembly into components. Similarly components are functionally tested prior to assembly into the instrument level. The Instrument Requirements Document shall be annotated with the name of the test procedure or analysis which is used to verify each requirement.

Functional and Environmental testing of the Flight Units at the various levels of assembly is summarized in Table 3-1

Table 3-1. Flight Unit Verification Summary

Test Description	Assembly	Component	Instrument	Observatory
Functional	√	√	√	√
Deployment	√	√	-	√
Self-Compatibility	-	-	√	√
EMC/EMI	-	-	√	√
DC Mag Field	-	√	-	√
AC Mag Field	-	-	√	-
Electrostatic Cleanliness (ESC)	-	√	-	√
Mass Properties	-	√	-	√
Cleanliness	-	√	-	√
Vibration	-	√	-	√
Acoustics	-	-	-	√
Self-Shock	-	√	-	√
Thermal Balance	-	-	-	√
T/V (Cycles)	-	√ (4)	√ (2)	√ (4)

### 3.1 Comprehensive Performance Test (CPT)

The CPT is a detailed functional test conducted under conditions of varying internal and external parameters with emphasis on all possible modes of operation. The CPT includes all instrument commands and modes of operation, to the maximum extent possible. By spacecraft integration, the CPT is expected to be an automated test. The CPT is expected to be conducted immediately after EFW is integrated; before and after any vibration tests; and before, during, and after Thermal Vacuum testing. It does not include boom deployment, but may include deployment simulators attached to the boom units. The typical CPT uses internal test signal generation and requires E-Field requires approximately 30 minutes to run. A longer version of this test, not done at the Observatory level, requires external stimulus attached to the boom units.

Requires: S/C Emulator, Emulator GSE Laptop, Boom Loads Box, Motor Simulators.

Required Personnel: Test Conductor

Instrument Safety & Constraints: ESD protection used when handling hardware, Deployment enable plugs should not be installed on boom units.

Pass /Fail Criteria: Instrument performs as expected and within limits. All commands are received and executed correctly. All telemetry is received and housekeeping values are within specified range and science data shows correct EFW functionality.

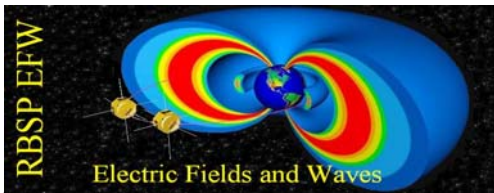

### **3.2 Limited Performance Test (LPT)**

The LPT is a short functional test conducted under conditions of typical parameters with emphasis on all interconnections. The LPT includes representative instrument commands and modes of operation based upon meeting time limitations. By spacecraft integration, the LPT is expected to be an automated test. The LPT is expected to be conducted immediately after EFW is integrated; and at places in the spacecraft flow when transportation has occurred or reconfigurations have been performed. The typical LPT uses internal test signal generation and ideally has the Boom Loads Box connected to allow for deployment simulation; however there is flexibility in this requirement at the spacecraft level. The LPT requires approximately 15 minutes to run.

Requires: S/C Emulator, Emulator GSE Laptop, Boom Loads Box

Required Personnel: Test Conductor

Instrument Safety & Constraints: ESD protection used when handling hardware, Deployment enable plugs should not be installed on boom units.

Pass /Fail Criteria: Instrument performs as expected and within limits. All commands are received and executed correctly. All telemetry is received and housekeeping values are within specified range and science data shows correct EFW functionality.

### **3.3 Aliveness Test (AT)**

The Aliveness test powers up the EFW and verifies it draws nominal current on all axes, produces nominal telemetry and executes commands. The test verifies all wires are functioning between EFW and the spacecraft electronics, and verifies all wires in the EFW harnesses to its SPB and AXB units. The test is expected to take about 5 minutes.

Requires: S/C Emulator, Emulator GSE Laptop.

Required Personnel: Test Conductor

Instrument Safety & Constraints: ESD protection used when handling hardware, Deployment enable plugs should not be installed on boom units.

Pass /Fail Criteria: Instrument performs as expected and within limits. All commands are received and executed correctly. All telemetry is received and housekeeping values are within specified range and science data shows correct EFW functionality.

### **3.4 EMFISIS Interface Tests**

The noise level of the EFW signals to EMFISIS will be tested on the ETU and flight units to verify we meet the requirement. An interface test with the EMFISIS instrument shall be performed using the ETU of both instruments around the time of ICDR. This test shall verify signals are as expected and signal performance requirements are met. A second test of the EFW and EMFISIS flight instruments is also planned to occur prior to spacecraft integration.

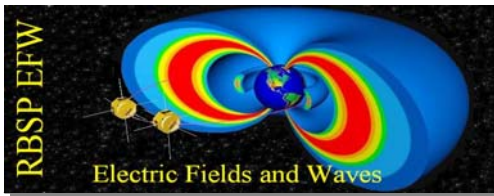

An interface test of the flight units will be performed at the Observatory level, during which inter-instrument timing will be verified (SFTP test described below), and the backup MAG data path through EFW can be tested.

Requires: EMFISIS, EMFISIS required GSE, S/C Emulator, Emulator GSE Laptop, Faraday Boxes for sensors.

Coordinated Efforts: Requires support of EMFISIS team.

Required Personnel: Test Conductor

Instrument Safety & Constraints: ESD protection used when handling hardware, Deployment enable plugs should not be installed on boom units.

Pass /Fail Criteria: Instrument meets or exceeds specification laid out in EMFISIS to EFW ICD.

### **3.5 Spacecraft Interface ETU Test**

An electrical interface test shall be performed between the ETU EFW IDPU and the spacecraft ETU electronics to verify the interface is performing per the ICD (this is primarily a signal interface test, not a power test). This test shall occur at APL around the time of CDR or as soon as APL is able to support such a test.

Requires: Emulator GSE Laptop

Coordinated Efforts: APL S/C I&T Team.

Required Personnel: Test Conductor

Instrument Safety & Constraints: ESD protection used when handling hardware.

Pass /Fail Criteria: Instrument is able to send TM, HSK, and receive commands and the 1PPS/SP.

### **3.6 Boom Deployments**

Boom deployment testing takes place at the component level (AXB, SPB). A minimum of 2 full deployments will take place on each unit prior to the start of the environmental test program. In addition, during component level thermal vacuum tests, there will be one deployment at hot (Bus Voltage 35V) and one at cold (Bus Voltage 24V). Special GSE and conditions are required for these deployments which are typically inconsistent with deployments at the Instrument or Observatory levels. During functional tests at the instrument and Observatory level, actuator simulators shall be used to verify the ability of the system to run the deployment of the booms. A frangibolt (for AXB) and pin puller (for SPB) will be fired using the IDPU on each flight unit to verify that it can successfully actuate the device. Hi-fidelity motor simulators will be used to verify the IDPU can deploy the booms correctly. One deployment test of the SPB and one deployment test of the AXB will be run through the IDPU. Unless otherwise stated boom deployment is done at a bus voltage of 30V.

Requires: S/C Emulator, Emulator GSE Laptop, Boom Loads Box, Motor Simulators, Frangibolt.

Required Personnel: Test Conductor, Cog-E for SPB, Cog-E for AXB.



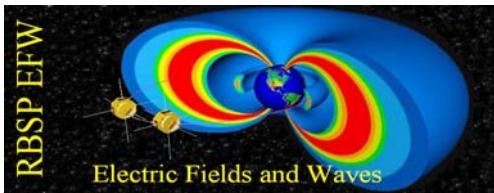

Instrument Safety & Constraints: ESD protection used when handling hardware.

Pass /Fail Criteria: Instrument performs as expected and within limits. Booms / Simulators are deployed correctly.

### **3.7 Observatory-Level Boom Deployments**

#### AXB

At the Observatory Level, the AXB whip deployment will be demonstrated one time. This requires the spacecraft be oriented to G-negate the deployment. The whip can be re-stowed without removal of the AXB from the spacecraft. Analysis will be performed to verify adequate margins/compliance to temperature extremes and gradients across the spacecraft deck. No Observatory-level stacer deployments will be performed due to the complication and risk of setting up appropriate GSE.

Requires: GSE Laptop, Enable plug that allows whip deployment but not stacer and motor deployment.

Coordinated Efforts: APL S/C I&T Team.

Required Personnel: Test Conductor, Cog-E for AXB.

Instrument Safety & Constraints: ESD protection used when handling hardware.

Pass /Fail Criteria: Whip deploys correctly.

#### SPB

The SPB shall be deployed one time at Observatory Level in preparation for the EMC self-compatibility test (radiated) so we can directly measure the spacecraft-generated noise in the EFW (and EMFISIS) bands, albeit with shortened booms and so more sensitivity to spacecraft noise. This shall be a pop-and-catch deployment followed by a walk out of a few meters of wire (as far from the spacecraft as practical given the facility constraints) and installation of the SPB sensors in a UCB-provided MGSE. UCB personnel shall perform all handling of the SPB sensors. This also gives us an end-to-end test of the deployment system (actuators and motors).

While in this configuration we should take advantage of the booms being partially deployed to do an EFW FTP test (see section 4.2) and Usher and Guard Test (see section 4.5).

After this test the four SPB must be removed from the spacecraft for the EFW team to re-stow them. The AXB will not be deployed in this test.

Requires: GSE Laptop, SPB Enable Plugs.

Coordinated Efforts: APL S/C I&T Team.

Required Personnel: Test Conductor, Cog-E for SPB.

Instrument Safety & Constraints: ESD protection used when handling hardware.

Pass /Fail Criteria: SPB deploys correctly.

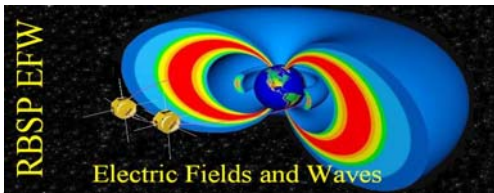

### **3.8 Verification Other than Test**

The following items are verified by means other than test:

Static Loads – from Solidworks finite element analysis.

Unit Venting / Pressure – uses GSFC approved 2sq inches / cubic ft

Alignment on Spacecraft – This analysis is a collaboration between spacecraft and EFW engineers.

Deep Dielectric Discharge – Analysis provided by APL that 350 mils of Al will protect internal electronics from DDD. First circuits are examined for sensitive components, which are then tested either by EFW or APL.

## **4. Science Calibrations**

There are four calibration tests required to verify the EFW instrument performance as described in the Instrument Requirements Document. These tests are performed one time for each flight unit prior to environmental tests.

These tests make use of standard laboratory DC power supplies and AC signal generators to provide the excitation voltages to the EFW sensors required for the calibration procedures. The output (amplitude, phase, frequency, harmonic content) of these signal sources are monitored as needed by DMMs (typically Fluke 189 or equivalent), digital oscilloscopes, or spectrum analyzers. The calibration of both the signal sources and measurement instruments is maintained by contract with an external vendor as needed.

A modest amount of custom EGSE is needed to support the calibration tests. This includes the following items: EM-shielded enclosures (a.k.a. Faraday Boxes) that are fabricated on-site, and checked for DC continuity as needed during testing; analog-to-digital data acquisition hardware that is calibrated (gain, offset, frequency response) using the laboratory signal sources and measurement instruments; high-gain, low-noise, battery-powered amplifier boxes that are used for noise floor measurements that are calibrated (gain, offset, frequency response, background noise level) using the laboratory signal sources and measurement instruments.

Data taken during SciCal is typically drawn directly into Matlab, processed, and the results (including standard statistical error analysis of derived parameters) dumped directly to ASCII log files that become part of the End Item Data Package for the instrument.

Data taken during the other calibration procedures is taken on the EFW instrument itself, and stored as PTP files by the EFW GSE. Post-processing of those PTP files occurs in IDL, with either the production of ASCII log files of results, or recording of results in test reports.

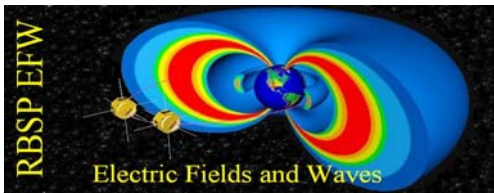

#### **4.1 Science Calibration (SciCal)**

This test verifies DC gain and offset and AC gain and phase for the sensors and bias channels, plus the DAC calibration for the bias channels. The test is done at the subassembly level (prior to instrument integration), and involves boom pairs plus the BEB board.

Requires: Sci Cal GSE rack.

Required Personnel: Test Conductor.

Instrument Safety & Constraints: ESD protection used when handling hardware.

Pass / Fail Criteria: None.

#### **4.2 Fields Timing and Phasing (FTP)**

This test verifies the absolute and relative timing and phasing (polarity and shift) amongst all fields data (EFW, MSC, MAG). It is done at the Instrument level of assembly, with partially deployed EFW sensors and simulators for MSC and MAG.

Requires: S/C Emulator, Emulator GSE Laptop, MAG and MSC simulators.

Required Personnel: Test Conductor.

Instrument Safety & Constraints: ESD protection used when handling hardware.

Pass / Fail Criteria: None.

A simplified version of this test (SFTP), not requiring partial EFW boom deployment, shall be done at the Spacecraft level of integration using the flight EMFISIS instruments and a common EFW-provided stimulation GSE source to verify instrument relative timing between EFW and EMFISIS. This test can also be used to verify the EFW back-up MAG data path to the MOC.

A second Observatory-level EFW FTP test shall be done during the Spacecraft compatibility test for which we do plan to deploy the SPB booms, enabling a better full FTP test to be performed.

Requires: GSE Laptop, signal generator.

Coordinated Effort: EMFISIS Team.

Required Personnel: Test Conductor.

Instrument Safety & Constraints: ESD protection used when handling hardware.

Pass / Fail Criteria: None.

#### **4.3 Omnibus DFB Spectral Data Test**

This test verifies end-to-end function of the DFB spectral and derived data quantities at the integrated instrument level (a similar test is run at the DFB level). It requires the same configuration as FTP.

Requires: S/C Emulator, Emulator GSE Laptop, MAG and MSC simulators, signal generator.

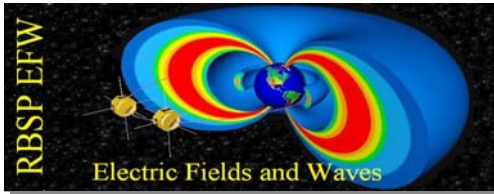

Required Personnel: Test Conductor.

Instrument Safety & Constraints: ESD protection used when handling hardware.

Pass / Fail Criteria: None.

#### **4.4 Slew Rate and DC and AC CMRR Test**

This test verifies the instrument slew rate and common mode rejection ratio in an integrated instrument configuration (a similar test is run at the DFB level). It requires the same configuration as FTP.

Requires: S/C Emulator, Emulator GSE Laptop, MAG and MSC simulators, signal generator.

Required Personnel: Test Conductor.

Instrument Safety & Constraints: ESD protection used when handling hardware.

Pass / Fail Criteria: None.

#### **4.5 Guard and Usher Test**

This test tests the guard and usher surfaces of the preamps when they are deployed from the observatory during EMC testing. It consists of commanding the instrument to drive the surfaces to particular potentials and verification that the correct voltages are set with a volt meter.

Requires: GSE Laptop, Voltmeter.

Coordinated Efforts: Spacecraft I&T Team.

Required Personnel: Test Conductor, test helper.

Instrument Safety & Constraints: ESD protection used when handling hardware.

Pass / Fail Criteria: Voltages are recorded by voltmeter as commanded.

### **5. Environmental Test Program**

This section describes the environmental test program that will be conducted to verify that the Instrument Payload meets the environmental requirements of the RBSP Mission as described in 7417-9019 and 7417-9018. Deviations to those requirements will be submitted to the Project CCB for approval and will be listed in the on-line document RBSP\_EFW\_Waivers (waiver numbers indicated below as RBSP\_EFW\_CCR\_xxx). Significant features of the program are:

- Radiation and Deep Dielectric Discharge requirements shall be verified by analysis, based on shielding and EEE part susceptibility. Active EEE part radiation data shall be reviewed and approved by the Project Parts Control Board. As the IDPU wall thickness is 350mils, only DDD events from the interfaces will be analyzed/tested.

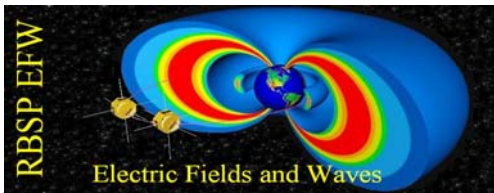

Also the EFW preamp has less than 350mil shielding, and so will be tested for DDD susceptibility.

- The EFW components are thermally coupled to the spacecraft deck. For this reason, no instrument level thermal balance testing will be performed. However, during thermal vacuum testing the temperatures of various internal nodes will be monitored to ensure that those temperatures do not exceed their operating range.
- EFW does not expect any significant response to launch transients described in 7417-9019 section 5.3 due to the component locations on the bus. This shall be verified by thermal analysis; any significant effect shall be included in the thermal vacuum survival test cycle.
- EFW ETU units are planned to be qualification models, and vibration tests will be performed to qualification levels. Assuming no significant changes between ETU and Flight Units, Flight Units will be vibrated to Acceptance levels (RBSP\_EFW\_CCR\_009)
- Vibration testing shall be performed unpowered (as the unit will be during launch) to avoid any additional risk and complications. EFW will perform no functional tests between vibration tests or axes; full inspection and functional testing shall be performed before and after the full suite of vibration tests. EFW may use force limiting as part of the vibration testing. (RBSP\_EFW\_CCR\_003, RBSP\_EFW\_CCR\_005, RBSP\_EFW\_CCR\_010)
- EFW is not susceptible to acoustic energy (no thin foils, etc), and so no acoustic testing at the instrument level is planned. The EFW components will be well vented and shall demonstrate pressure profile accommodation by rule-of-thumb analysis (RBSP\_EFW\_CCB\_008).
- EFW has no sealed volumes, so no leakage testing will be performed.

### **5.1 ETU Testing**

EFW plans to do qualification tests on the ETU unit prior to ICDR, and acceptance level tests on the flight unit prior to delivery to Spacecraft I&T. Qualification Tests to be performed on the EFW ETU include:

- Mass properties (Mass, CG, MOI) shall be measured per 7417-9019 Section 5.7. For deployable booms, mass properties will be measured in the stowed case and analytical values will be used (SolidWorks) for the deployed case.
- Vibration (modal survey, sine, and random) to Qualification levels per 7417-9019 Section 5.4.5 at the Component level (IDPU (no electronics), SPB, AXB). Pass criteria for these tests are visual inspection of hardware post vibration and where appropriate functional test.

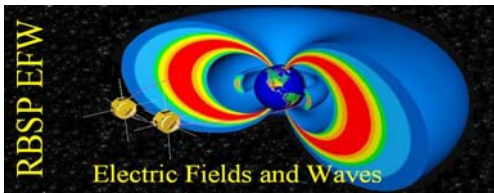

- Self-shock survival from boom deployments actuations shall be demonstrated at the component level (SPB and AXB) by at least 2 actuations (only the initial release generates a shock). Pass criteria for these tests are visual inspection of hardware post vibration and where appropriate passing a functional test.
- The ETU shall be thermal-vacuum cycled at the component level (2 operational cycles plus 1 survival cycle, per the requirements and limits indicated in 7417-9019 section 5.3.2) for the AXB and SPB. Boom deployment tests will be performed at hot and cold levels (one time each). AXB deployment testing will be performed at the subassembly level for the Whip and Caging Mechanism; Stacer deployment will be performed at the assembly level. In addition preamplifiers will be separately tested (since they have different thermal limits from the boom units) at the subassembly level (2 operational cycles plus one survival cycle). Preamp temperature limits are based on thermal analysis and are +90C to -170C for both operational and non-operational cycles. IDPU Thermal Vacuum will consist of only the analog circuit cards (BEB and LVPS). It is expected these will happen together with the DCB and DFB run outside of the chamber, or appropriate loads will be used in their place. The DCB and DFB boards have commercial grade FPGAs and are not suitable for vacuum testing. Pass criteria for these tests are visual inspection of hardware post deployment and where appropriate passing a functional test during hot and cold cycles.
- The ETU EFW components will be ‘sniffed’ magnetically (DC fields and any fields induced when the unit is powered) to verify they are within spec. Results will be forwarded to the EME working group for analysis who hold the pass / fail criteria.
- The ETU shall undergo a subset of the full EMC test at the instrument level, consisting of Conducted Emissions testing (CE01, CE03), possibly Conducted Susceptibility tests (CS03) – TBR, Turn-on/Turn-off Transient, and Bonding and Isolation testing per 7417-9018. ETU harnessing will be used between the EFW components, and the booms shall not be deployed. Pass / fail criteria is listed in the EMECP.
- A DDD test will be performed on the ETU. This requires the all ETU components (IDPU, SPB and AXB) as well as the ETU harnessing. An electrical discharge of level 5000V will be made near each box as per APL test procedure. The pass criteria for this test is that the instrument should function normally during each pulsed discharge.

## **5.2 Flight Unit Environmental Testing**

EFW shall perform the following tests on the Flight Unit prior to delivery to the spacecraft I&T (and after instrument PER):

- Mass properties (Mass, CG, MOI) shall be measured per 7417-9019 Section 5.7. For deployable booms, mass properties will be measured in the stowed case and analytical values will be used (SolidWorks) for the deployed case.

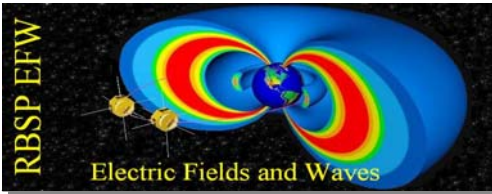

- Vibration (modal survey, sine and random) to Acceptance levels (3dB below protoflight levels) per 7417-9019 Section 5.4.5 at the Component level for the SPB, AXB. IDPU vibration will be at protoflight levels (not done on ETU). Pass criteria for these tests are visual inspection of hardware post vibration and where appropriate functional test.
- Self-shock survival from boom deployments actuations shall be demonstrated at the component level (SPB and AXB) by at least 2 actuations (only the initial release generates a shock). Pass criteria for these tests are visual inspection of hardware post vibration and where appropriate passing a functional test.
- The boom preamps shall receive 6 operational plus one survival thermal vac cycle at the subassembly level (due to the wider range of temperatures experienced by the preamps on orbit, compared to the boom units they are part of) at +105C to -170C. At the component level (IDPU, SPB, AXB) the units will receive 4 operational plus one survival thermal vac cycle. Boom deployment tests will occur once each at the last hot and cold limits. AXB deployment testing will be performed at the subassembly level for the Whip and Caging Mechanism; Stacer deployment will be performed at the assembly level. Two additional operational thermal vac cycles (with no boom deployments, but deployment tests using actuator simulators) will be performed at the Instrument level, making a total of 6 operational and one survival cycle, per 7417-9019 section 5.3.2. See figures 5.2-1 and 5.2-2 below, which show the cycling and when the CPT and LPT tests will be performed. (RBSP\_EFW\_CCR\_007). Pass criteria for these tests are visual inspection of hardware post deployment and where appropriate passing a functional test during hot and cold cycles.

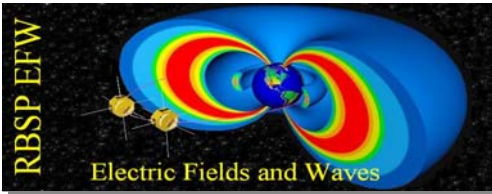

Typical Component Thermal Vacuum Profile

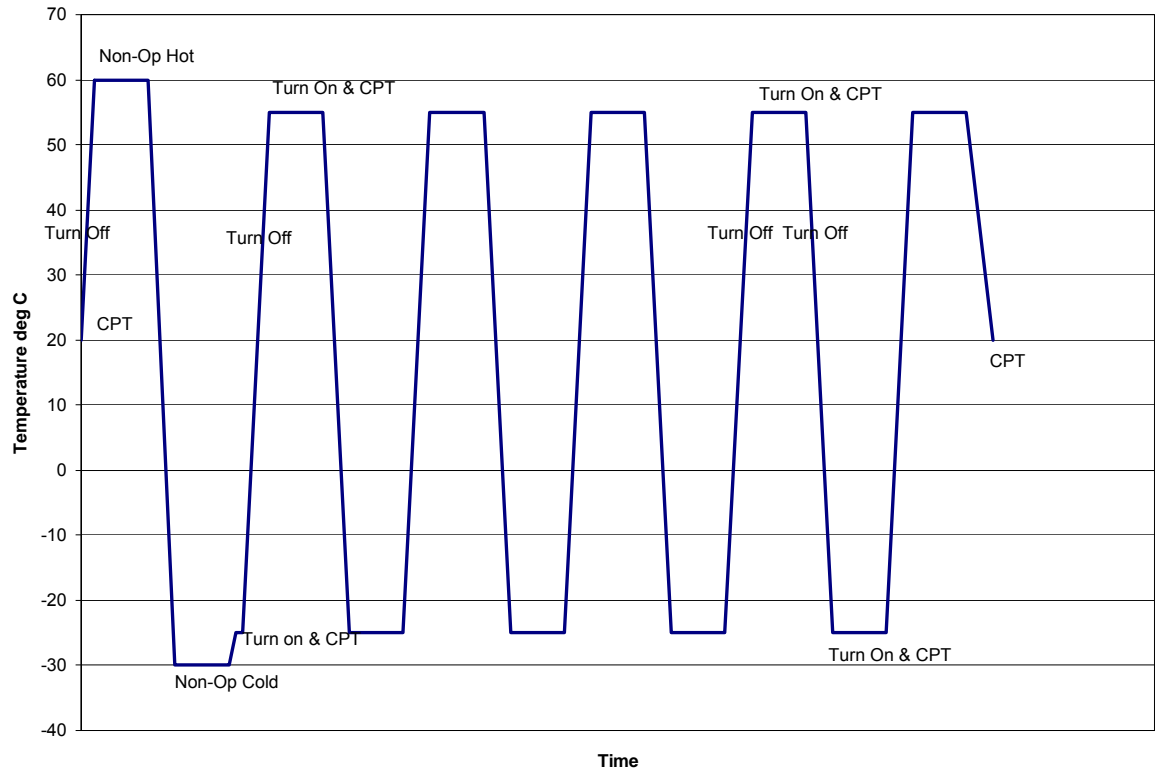
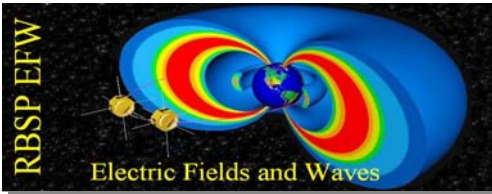

Figure 5.2-1, Component Level Thermal Vac Test





Typical Instrument Thermal Vacuum Profile

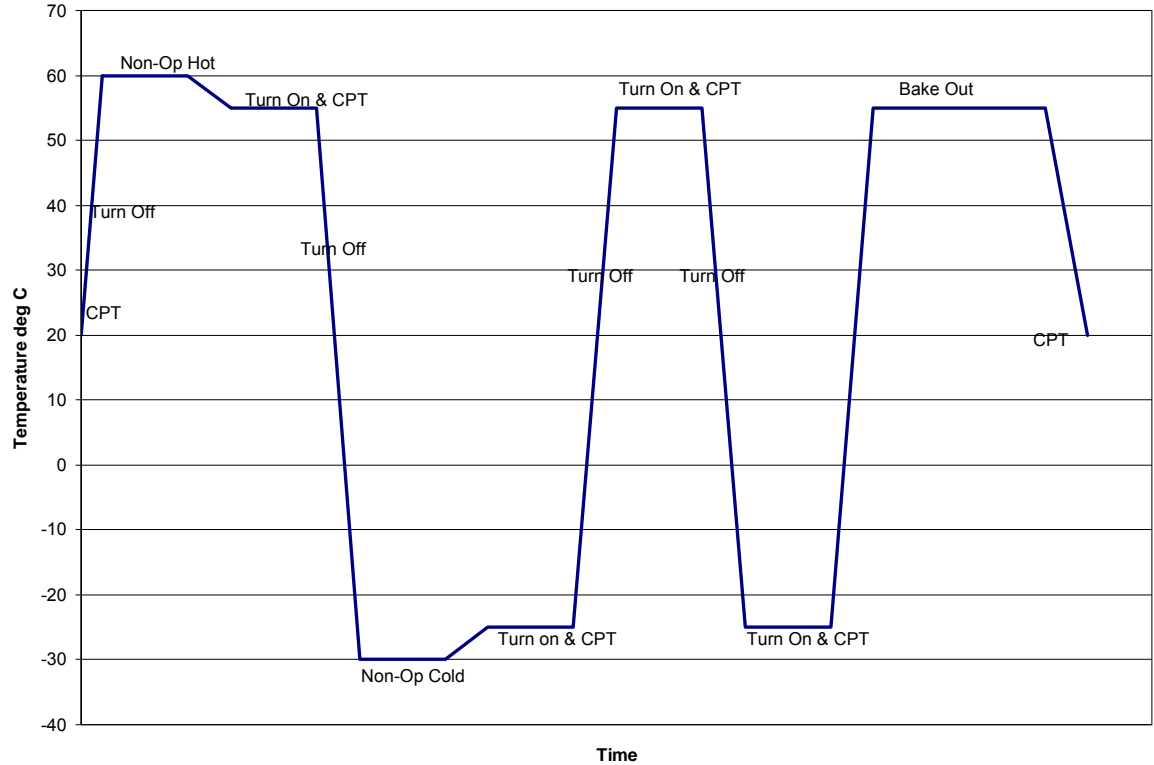
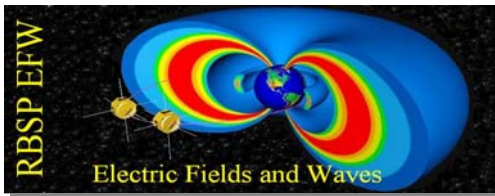

Figure 5.2-2, Instrument Level Thermal Vacuum Test

- The EFW components will be ‘sniffed’ magnetically (DC fields and any fields induced when the unit is powered) to verify they are within spec (<5nT DC, <0.1nT AC at magnetometer location for all spacecraft components). Results will be compared to ETU measurements and forwarded to the EME working group for analysis who hold the pass / fail criteria.
- A full set of EMC test shall be performed at the instrument level for the first flight unit, with a limited set of tests for the second flight unit, per 7417-9018. Pass / fail criteria is listed in the EMECP.
- Component level Bakeout will be performed per the EFW Contamination Control Plan (RBSP\_EFW\_005, RBSP\_EFW\_007), possibly combined with the thermal vacuum test (TBR).
- A CPT will be run on the EFW instrument at the end of the environmental test program (usually at the end of instrument thermal vacuum) prior to shipping to spacecraft I&T.



- The instrument will be inspected and cleaned as required by the EFW Contamination Control Plan prior to delivery to spacecraft I&T.

## 6. Integration and Test

### 6.1 Integration and Test Flow

Figure 5-1 summarizes the Integration and Test Flow for the EFW Instrument Engineering Test Unit (ETU). Figure 5-2 shows the I&T flow for the flight units. Note that the only difference between the two flight units is that the second has a reduced EMC test as called out in 7417-9018.

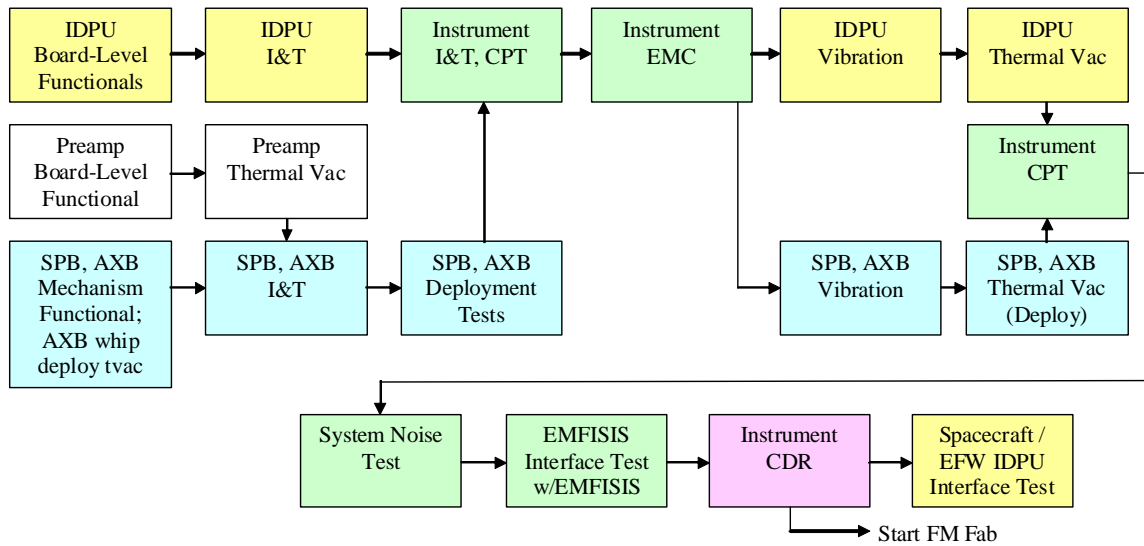

Figure 5-1, ETU I&T Flow

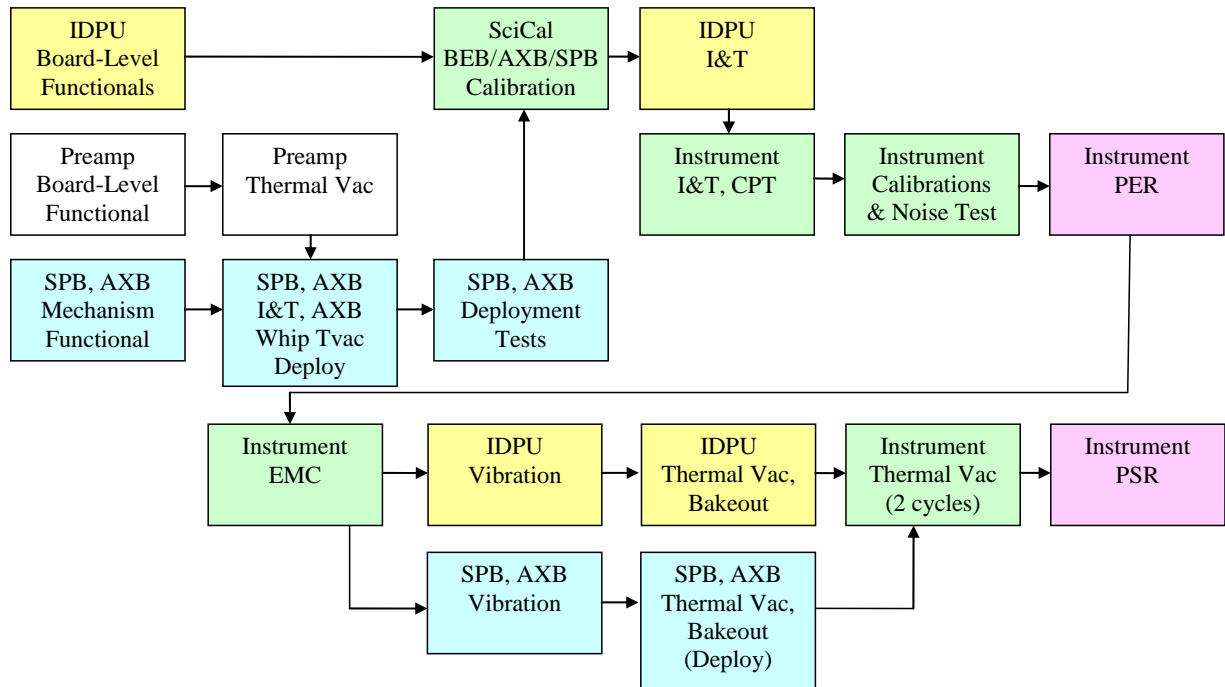
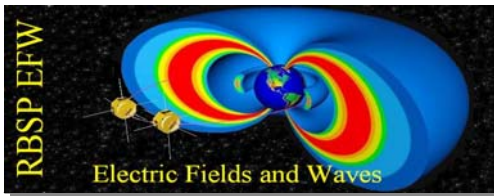

Figure 5-2, FM I&T Flow

## 6.2 Integration and Test Facilities

### Calibration

EFW Science Calibration (SciCal) will use the electric field calibration facility at SSL.

### Integration

Initial IDPU board integration will be conducted at SSL electrical labs. Once flight boards have been staked and conformal coated the boards will be stored and tested in a SSL clean room (class 100,000). Instrument integration of the IDPU to the booms will occur in the same clean room.

### Instrument Tests

This includes the Fields Timing and Phasing (FTP) Test, the Omnibus DFB Spectral Test, the Slew Rate, DC and AC CMRR Test, and SPB Deploy. These will occur after instrument integration and will occur in the same clean room used for instrument integration.

### Vibration

Unit vibration will take place at Quanta Labs in San Jose.

### EMC

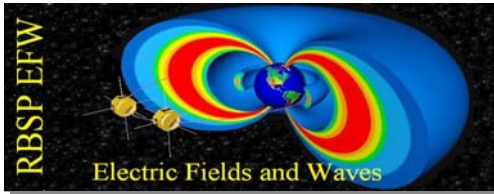

---

Instrument EMC tests will take place at SSL for the conducted tests planned for the ETU and second FM. The full EMC tests will be carried out at an external EMC facility.

#### Thermal Vacuum & Bakeout

Instrument Thermal Vacuum & Bakeout will use SSL in house TVAC chambers. Bake out is run according to SSL procedures using a TQCM.

### **6.3 Limited Life Items**

Limited life items are recorded in RBSP\_EFW\_MA\_002\_9. Currently there are no limited life items on EFW as identified by the criteria, but EFW does track a number of items on an as used basis such as connector mates, EEPROM writes etc.

### **6.4 Contamination and Control**

EFW Contamination Control plan is detailed in RBSP\_EFW\_SE\_008.

### **6.5 Transportation and Preservation of the Instrument**

The EFW instrument should be stored in a class 100,000 cleanroom or better. EFW has no need for Nitrogen purge. When shipping, the instrument will be housed in either custom built or designated containers. Shipping details are provided in the EFW users manual.

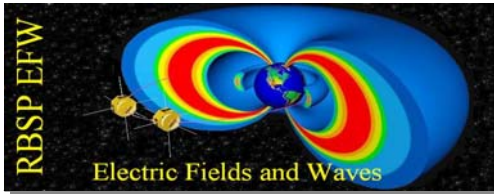

## 7. Environmental Test Matrix (Rev H)

RBSP EFW ENVIRONMENTAL TEST MATRIX

COMPONENT (ITEM)	HARDWARE		MECHANICAL										ELECTRICAL							THERMAL		CONTAM.		OTHER										
	QUANTITY	SUPPLIER	ALIGNMENT	MODAL SURVEY	STATIC LOAD	RANDOM VIBRATION	SINE VIBRATION	ACOUSTIC	PROOF TEST	CLAMP BAND SHOCK	VENTING/PRESS. PROFILE	MASS PROPERTIES	MECH FN. - DEPLOY	INTERFACE VERIFICATION	EMFISIS INTERFACE TEST	BONDING AND ISOLATION	TURN ON/OFF TRANSIENTS	CONDUCTED EMISSIONS	CONDUCTED SUSCEPTIBILITY	RADIATED EMISSIONS	RADIATED SUSCEPTIBILITY	ESD DISCHARGE TEST	SELF COMPATIBILITY	THERMAL VACUUM (# CYCLES)	THERMAL BALANCE	ESC AND GROUNDING	DC MAGNETICS	BAKEOUT	RADIATION	DEEP DIELECTRIC DISCHARGE	FAILURE FREE HOURS			
ETU	1	UCB	T15	T1	A1, T4	T1	T1					M1	T12	T6	T5	T7	T7	T7				T7	T	3			M2							
Instrument	2	UCB	T14											T6	T7	T7	T7	T7	T7			T	2, T16									100		
EFI SPB	8	UCB		T1	A1, T4	T3	T3					A2	M1	T12	T6								5											
SPB Pre-amp	8	UCB																					7											
EFI AXB	4	UCB																																
AXB Deploy Mech	4	UCB		T1	A1	T3	T3																											
AXB less whip (*)	4	UCB	T15		T4									T13	T12								5											
AXB Pre-amp	4	UCB																					7											
AXB Cage/whip	4	UCB	T		A1									T12									5											
Tube	2	UCB		T	T2	T2		T															7											
IDPU	2	UCB		T1	A1	T3	T3																5			T	M2							
Instrument Harness	2	UCB																																
Instrument on S/C	2	UCB	A	T		T	T	T					T14	T	T	T	T	T					T14	T	T	T	T							

notes:

(\*) "AXB less whip" is the AXB Deployment mechanism less the Cage/whip/preamp

A1 Analysis to show safety margins per 7417-9019

A2 Units follow design rule of 1 sq in vent area/ft<sup>3</sup> of volume as per Waiver EFW-008

T1 Per 7417-9019

T2 Test conducted as part of Spacecraft Structure verification.

T3 Per 7417-9019 Section 5.4.5 for protoflight hardware. Test is done unpowered and no functional between axes as per waivers EFW-005 & EFW-003

T4 Cable assemblies on EFW Booms undergo static load test

T5 EMFISIS Interface test done with simulators, plus an ETU to ETU test, and finally on the spacecraft

T6 Safe-to-Mate and compliance to ICD prior to integration

T7 Per 7417-9018, full testing on F1, CE testing on ETU, F2

T9 Total Dose and SEE Testing at part level as needed

T10 60C for 48 hours prior to TV w/ integrated payload

T11 Contamination Verification w/ TQCM

T12 Deployments occur at start of test sequence (ETU and FM) and in thermal vac at temperature extremes; tests self-shock;

Whip and Caging Mechanisms will be deployed as a subassembly due to offloading requirements

T13 Whip deployment test after AXB vibration; then Whip removed and deployed again in thermal vac, stacer deployment in "AXB less Whip" thermal vac separately

T14 SPB partial deploy during Spacecraft EMC test. AXB Whip deploy test after S/C Vib & Deployment service testing with actuator simulators as agreed per Waiver EFW-004

T15 AXB runout measured during horizontal deployment testing

T16 Instrument level thermal vac test excludes the AXB Tube

M1 Mass, CG, MOI measured stowed; deployed by analysis

M2 DC Magnetics measured prior to Instrument Payload integration

M3 Mass only measured for the harness, no CG or MOI

A Analysis

T Test

M Measurement

Note that at delivery the flight units will have accumulated at least 300 hours of operation, 100 of which shall be failure free (7417-9096).

## 8. Test Documentation

- Test Procedures: Test Procedures are prepared for any test involving flight hardware. These procedures will be peer reviewed by other members of the instrument team and by the engineer at the facility where the tests are performed. As appropriate, each procedure will identify the item level of assembly, configuration, test objectives (including specific requirements to be verified from the Instrument Requirements Document), pass/fail criteria, test facilities and instrumentation (GSE), operational safety considerations, contamination control requirements as well as a description of the functional operations and personnel responsibilities. All procedures require approval by the QA engineer, who will verify Mission Assurance and Safety issues are addressed,

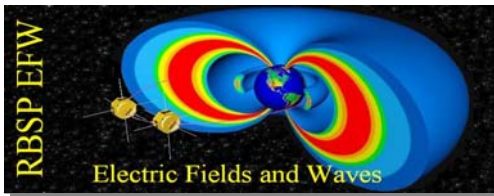

and the Systems Engineer, who will verify that the testing is adequate to demonstrate compliance with the Instrument Requirements.

- Test Reports: Test Reports will be written for all major tests on flight hardware. Test reports on developmental items or engineering units are not required unless they are part of the formal qualification plan. QA tracks all test reports.
- Problem Failure Reports (PFR): Unsatisfactory performance during flight hardware testing starting at the component level shall be documented using a PFR. Unsatisfactory performance is defined as (1) a performance deviation from the expected or predicted result or (2) a deterioration or change in performance that could prevent the test item from meeting its functional, operational or design requirements as related to the overall system function. The cognizant hardware engineer will inform the QA engineer of the initiation of the PFR. All PFRs are assigned a unique document number and reported via the EFW Configuration Control System. The PFR records the failure class level, failure description, notification, problem diagnosis, and problem correction information.